



Valve Connectors

Accessories2

DIN Form A.....3-4



DIN Form B.....5



I/S Form B6



DIN Form C7



I/S Form C8



MDC Receptacle & Plug Versions....9-15

Valve Connectors

Solenoid Valve Connectors

Circuit Diagrams ❖ Accessories

Valve Connectors with LEDs and surge suppression aides in diagnostics and protection of equipment.

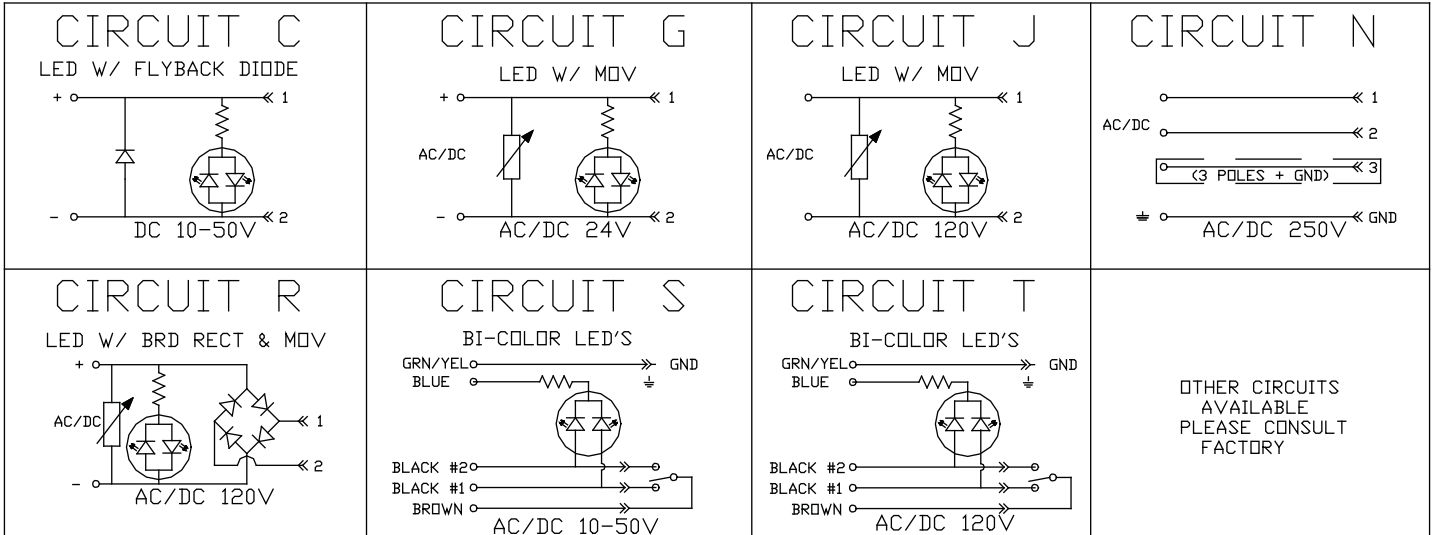

Male Bases: All connectors are made via solder tabs.

View	# of Poles	Maximum Conductor Size	Maximum Voltage	Material	Part Number
	2 + Ground	16 AWG	250 VAC	Polyamide	VMA-020-00
	3 + Ground	16 AWG	250 VAC	Polyamide	VMA-030-00

Thumb Screws

View	Material	Part Number	Form Style
	Nickel Plated Copper Alloy	V-25TB	Cable Version Form A (VA Series) Cable Version Form B (VB Series) Cable Version Industry Standard B (VD Series) Field Wireable Industry Standard C (VE Series)
	Nickel Plated Copper Alloy	V-30TB	Field Wireable Form A (VA Series) Field Wireable Form B (VB Series) Field Wireable Industry Standard B (VD Series)

DIN Form A (VA Series) Formed Gasket

View	Material	Part Number
	Thermoplastic	V-GPRA

All Valve Connectors come standard with mounting screws and a flat gasket.

Solenoid Valve Connectors

Field Wireable ❖ DIN 43650 ❖ Form A



# of Poles	Voltage	Circuitry	Housing Color	Field Wireable Styles		
				1/2" NPT	Pg 9	Pg 11
				Conduit	6 to 8 mm Cables	8 to 10 mm Cables
2 + Ground	250V AC/DC (maximum)	None	Gray	N/A	VFN-029-00	VFN-021-00
			Black	VAN-022-00	VAN-029-00	VAN-021-00
3 + Ground	250V AC/DC (maximum)	None	Gray	N/A	VFN-039-00	VFN-031-00
			Black	VAN-032-00	VAN-039-00	VAN-031-00
2 + Ground	10-50V DC	LED w/ Flyback Diode	Clear	VAC-022-00	VAC-029-00	VAC-021-00
2 + Ground	24V AC/DC	LED w/ MOV	Clear	VAG-022-00	VAG-029-00	VAG-021-00
2 + Ground	120V AC/DC	LED w/ MOV	Clear	VAJ-022-00	VAJ-029-00	VAJ-021-00
2 + Ground	120V AC/DC	Bridge Rectifier w/ LED & MOV	Clear	VAR-022-00	VAR-029-00	VAR-021-00
3 + Ground	10-50V AC/DC	2-LED; Amber & Green	Clear	Not Available	VAS-039-00	VAS-031-00
3 + Ground	120V AC/DC	2-LED; Amber & Green	Clear	Not Available	VAT-039-00	VAT-031-00

The ground position is not applicable for field wireable versions.

Specifications:

Body: Polyamide
 Contacts: Copper Alloy with Silver Plating
 Gasket: Thermoplastic
 Screw: Steel Zinc Plate
 Range: PG 9 - 6 to 8 mm
 PG 11 - 8 to 10 mm
 Temperature: -40°C to 125°C (-40°F to +257°F)
 Protection: IP 65

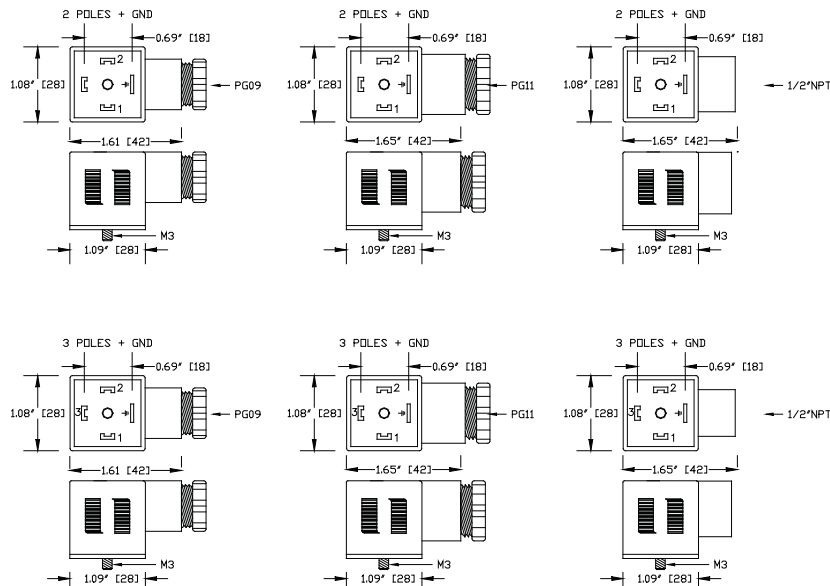



Solenoid Valve Connectors

Cabled Versions ❖ DIN 43650 ❖ Form A

# of Poles	Voltage	Circuitry See Page 216	Prewired Versions		
			2 M	5 M	10 M
2 + Ground	250V AC/DC (maximum)	None	VAN-220-00	VAN-520-00	VAN-A20-00
3 + Ground	250V AC/DC (maximum)	None	VAN-230-00**	VAN-530-00**	VAN-A30-00**
2 + Ground	10-50V DC	LED w/ Flyback Diode	VAC-220-00	VAC-520-00	VAC-A20-00
2 + Ground	24V AC/DC	LED w/ MOV	VAG-220-00	VAG-520-00	VAG-A20-00
2 + Ground	120V AC/DC	LED w/ MOV	VAJ-220-00	VAJ-520-00	VAJ-A20-00
2 + Ground	120V AC/DC	Bridge Rectifier w/ LED & MOV	VAR-220-00	VAR-520-00	VAR-A20-00
3 + Ground	10-50V AC/DC	2-LED; Amber & Green	VAS-230-00	VAS-530-00	VAS-A30-00
3 + Ground	120 V AC/DC	2-LED; Amber & Green	VAT-230-00	VAT-530-00	VAT-A30-00

For cables with 3 + Ground, two standard orientations are available. Please refer to the part number system shown above each drawing shown below.

Specifications:

Body: Black Polyamide
 Contacts: Copper Alloy with Silver Plating
 Gasket: Thermoplastic
 Screw: Steel Zinc Plate
 Cable: Black PVC
 2 Pole: 3x18 AWG; Cable O.D.: 0.26"
 3 Pole: 4x18 AWG; Cable O.D.: 0.27"
 Temperature: -40°C to 80°C (-40°F to +176°F)
 Protection: IP 65

Valve Pin #	Color Code	
	2 + Ground	3 + Ground
1	Brown	Brown
2	Blue	Gray*
3	N/A	Black
Ground	Green/Yellow	Green/Yellow

* Formerly Blue

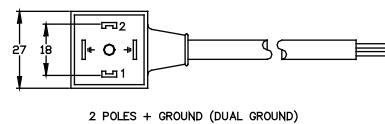
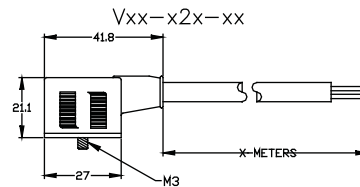

**2 Ground locations available for 3+ Ground versions.

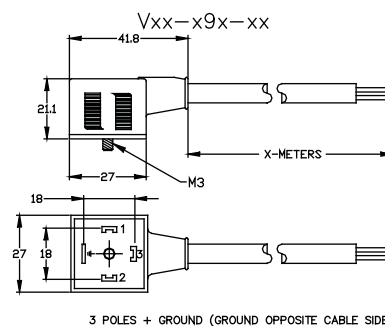
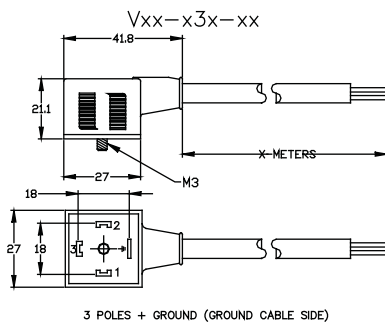

Solenoid Valve Connectors

Field Wireable & Cables ❖ DIN 43650 ❖ Form B



# of Poles	Voltage	Circuitry See Page 216	Field Wireable		Prewired Styles (Ground toward Cable)		
			1/2" NPT Conduit	PG 9 6 to 8 mm	2 M	5 M	10 M
2 + Ground	250 VAC (maximum)	None		VGN-029-00 (Gray)	VBN-220-00	VBN-520-00	VBN-A20-00
			VBN-022-00	VBN-029-00 (Black)			
2 + Ground	10-50V DC	LED w/ Flyback Diode	VBC-022-00	VBC-029-00	VBC-220-00	VBC-520-00	VBC-A20-00
2 + Ground	24V AC/DC	LED w/ MOV	VBG-022-00	VBG-029-00	VBG-220-00	VBG-520-00	VBG-A20-00
2 + Ground	120V AC/DC	LED w/ MOV	VBJ-022-00	VBJ-029-00	VBJ-220-00	VBJ-520-00	VBJ-A20-00

The ground position is not applicable for field wireable versions.

Specifications:

Body: Polyamide
 Contacts: Copper Alloy with Silver Plating
 Insert: Polyamide
 Gasket: Thermoplastic
 Screw: Steel Zinc Plate
 Temperature: -40°C to 80°C (-40°F to +176°F)
 Protection: IP 65

Valve Pin #	Color Code
1	Brown
2	Blue
Ground	Green/Yellow

Field Wireable Specifications:

Cable O.D.: PG 9 - 6 to 8 mm

Cable Version Specifications:

Body: Black Polyamide
 Cable: Black PVC
 2 Pole: 3x18 AWG; Cable O.D.: 0.26"

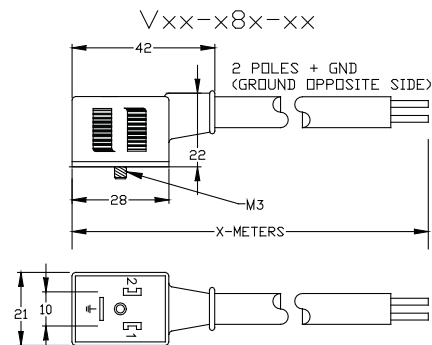
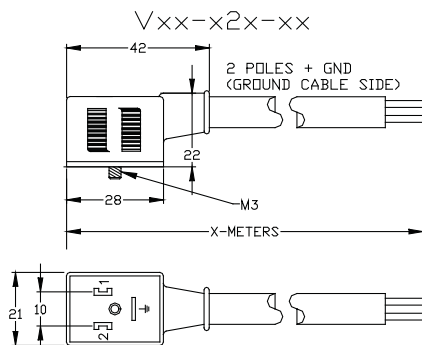
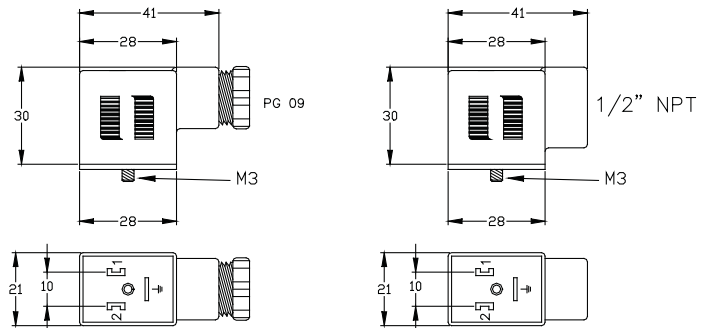

Valve Connectors



Solenoid Valve Connectors

Field Wireable & Cables ❖ Industry Standard ❖ Form B

# of Poles	Voltage	Circuitry See Page 216	Field Wireable		Prewired Styles (Ground toward Cable)		
			1/2" NPT Conduit	PG 9 6 to 8 mm	2 M	5 M	10 M
2 + Ground	250 VAC (maximum)	None		VJN-029-00 (Gray)	VDN-220-00	VDN-520-00	VDN-A20-00
			VDN-022-00 (Black)	VDN-029-00 (Black)			
2 + Ground	10-50V DC	LED w/ Flyback Diode	VDC-022-00	VDC-029-00	VDC-220-00	VDC-520-00	VDC-A20-00
2 + Ground	24V AC/DC	LED w/ MOV	VDG-022-00	VDG-029-00	VDG-220-00	VDG-520-00	VDG-A20-00
2 + Ground	120V AC/DC	LED w/ MOV	VDJ-022-00	VDJ-029-00	VDJ-220-00	VDJ-520-00	VDJ-A20-00

The ground position is not applicable for field wireable versions or for the unlighted molded versions. The unlighted molded versions can be plugged onto the coil in either direction. For other molded versions, there are two standard orientations available. Please refer to the part number system shown above each drawing shown below.

Field Wireable Specifications:

Body: Polyamide
 Contacts: Copper Alloy with Silver Plating
 Insert: Polyamide
 Gasket: Thermoplastic
 Screw: Steel Zinc Plate
 Cable O.D.: PG 9 - 6 to 8 mm
 Temperature: -40°C to 80°C (-40°F to +176°F)
 Protection: IP 65

Valve Pin #	Color Code
1	Brown
2	Blue
Ground	Green/Yellow

Cable Version Specifications:

Body: Black Polyamide
 Contacts: Copper Alloy with Silver Plating
 Insert: Polyamide
 Gasket: Thermoplastic
 Screw: Steel Zinc Plate
 Cable: Black PVC
 2 Pole: 3x18 AWG; Cable O.D.: 0.26"
 Temperature: -40°C to 80°C (-40°F to +176°F)
 Protection: IP 65

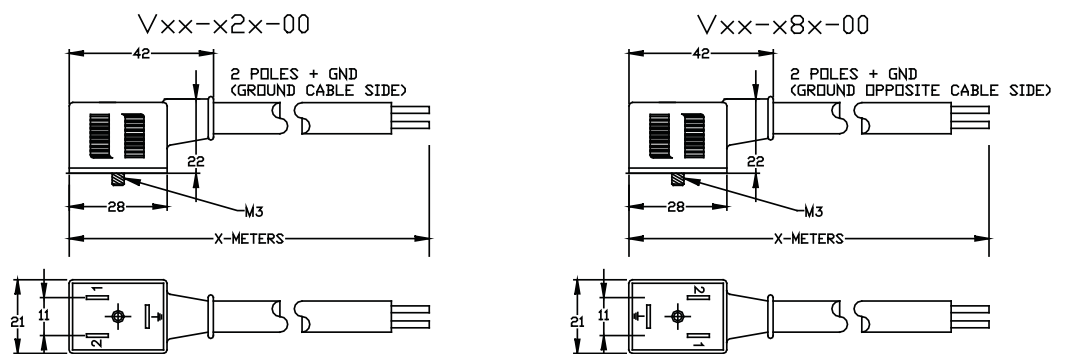
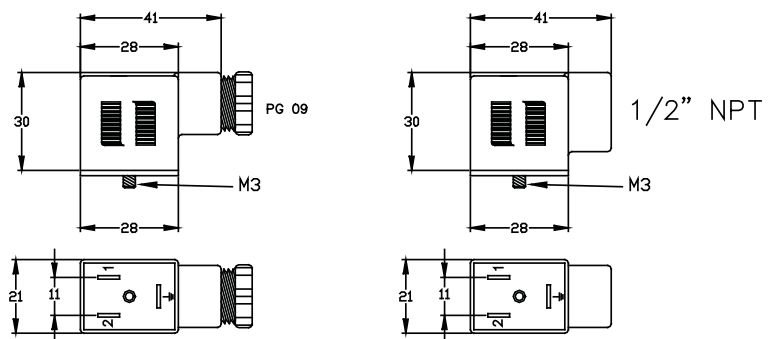

Solenoid Valve Connectors

Field Wireable & Cables ❖ DIN 43650 ❖ Form C



# of Poles	Voltage	Circuitry See Page 216 for Schematic	Field Wireable	Prewire Styles		
			Pg 7 6 to 7 mm	2 M	5 M	10 M
2 + Ground	250V AC/DC	None	VHN-027-00 (Gray)	VCN-220-00	VCN-520-00	VCN-A20-00
			VCN-027-00 (Black)			
3 + Ground	250V AC/DC	None	VHN-037-00 (Gray)	VCN-230-00**	VCN-530-00**	VCN-A30-00**
			VCN-037-00 (Black)			
2 + Ground	10-50V DC	LED w/ Flyback Diode	VCC-027-00	VCC-220-00	VCC-520-00	VCC-A20-00
2 + Ground	24V AC/DC	LED w/ MOV	VCG-027-00	VCG-220-00	VCG-520-00	VCG-A20-00
2 + Ground	120V AC/DC	LED w/ MOV	VCJ-027-00	VCJ-220-00	VCJ-520-00	VCJ-A20-00

The ground position is not applicable for field wireable versions.

Field Wireable Specifications:

Body: Polyamide
 Contacts: Copper Alloy with Silver Plating
 Insert: Polyamide
 Gasket: Thermoplastic
 Screw: Steel Zinc Plate
 Cable O.D.: PG 7 - 6 to 7 mm
 Temperature: -40°C to 80°C (-40°F to +176°F)
 Protection: IP 65

Valve Pin #	Color Code	
	2 + Ground	3 + Ground
1	Brown	Brown
2	Blue	Gray*
3	N/A	Black
Ground	Green/Yellow	Green/Yellow

* Formerly Blue

Cable Version Specifications:

Body: Black Polyamide
 Contacts: Copper Alloy with Silver Plating
 Insert: Polyamide
 Gasket: Thermoplastic
 Screw: Steel Zinc Plate
 Cable: Black PVC
 2 Pole: 3x20 AWG; Cable O.D.: 0.22"
 3 Pole: 4x20 AWG; Cable O.D.: 0.23"
 Temperature: -40°C to 80°C (-40°F to +176°F)
 Protection: IP 65

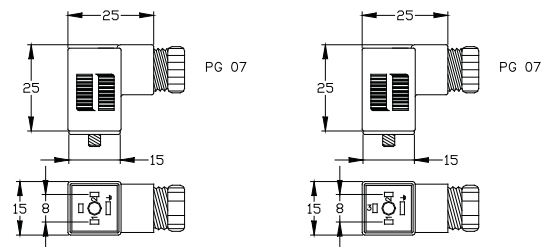

** 2 Ground locations available for 3+ Ground versions.

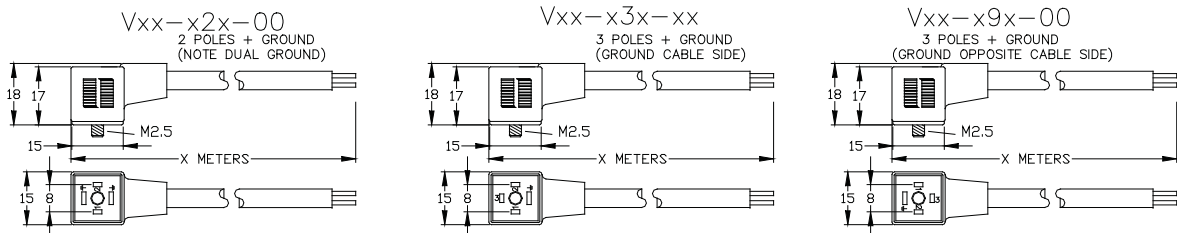



Solenoid Valve Connectors

Field Wireable & Cables ❖ Industry Standard ❖ Form C

# of Poles	Voltage	Circuitry See Page 216	Field Wireable	Prewired Styles		
			Pg 7 6 to 7 mm	2 M	5 M	10 M
2 + Ground	250V AC/DC	None	VKN-027-00 (Gray)	VEN-220-00	VEN-520-00	VEN-A20-00
			VEN-027-00 (Black)			
3 + Ground	250V AC/DC	None	VKN-037-00 (Gray)	VEN-230-00**	VEN-530-00**	VEN-A30-00**
			VEN-037-00 (Black)			
2 + Ground	10-50V DC	LED w/ Flyback Diode	VEC-027-00	VEC-220-00	VEC-520-00	VEC-A20-00
2 + Ground	24V AC/DC	LED w/ MOV	VEG-027-00	VEG-220-00	VEG-520-00	VEG-A20-00
2 + Ground	120V AC/DC	LED w/ MOV	VEJ-027-00	VEJ-220-00	VEJ-520-00	VEJ-A20-00

The ground position is not applicable for field wireable versions.

Field Wireable Specifications:

Body: Polyamide
 Contacts: Copper Alloy with Silver Plating
 Gasket: Thermoplastic
 Screw: Steel Zinc Plate
 Cable O.D.: PG 7 - 6 to 7 mm
 Temperature: -40°C to 80°C (-40°F to +176°F)
 Protection: IP 65

Valve Pin #	Color Code	
	2 + Ground	3 + Ground
1	Brown	Brown
2	Blue	Gray*
3	N/A	Black
Ground	Green/Yellow	Green/Yellow

* Formerly Blue

Cable Version Specifications:

Body: Black Polyamide
 Contacts: Copper Alloy with Silver Plating
 Gasket: Thermoplastic
 Screw: Steel Zinc Plate
 Cable: Black PVC
 2 Pole: 3x20 AWG; Cable O.D.: 0.22"
 3 Pole: 4x20 AWG; Cable O.D.: 0.23"
 Temperature: -40°C to 80°C (-40°F to +176°F)
 Protection: IP 65

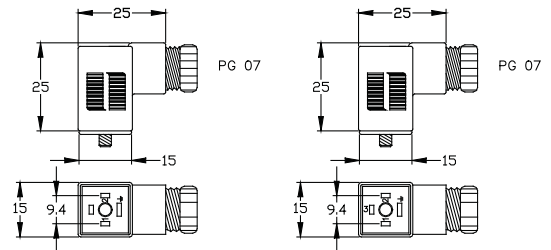

** 2 Ground locations available for 3+ Ground versions.

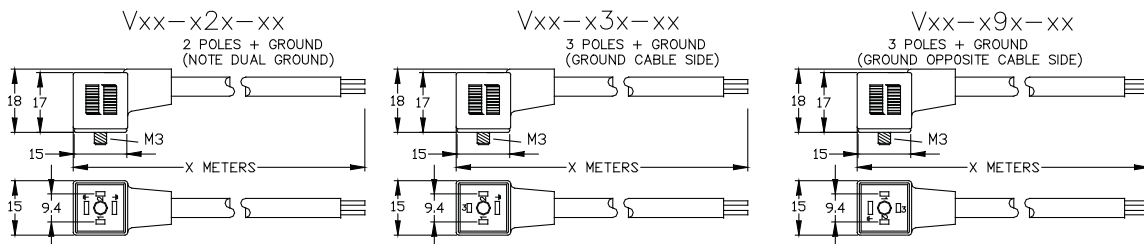

Solenoid Valve Connectors



DIN A to Micro-DC Male Receptacle ❖ DIN 43650 ❖ Form A to M12 (MDC)

# of Poles	Voltage	Circuitry See Page 216	Housing Color	M12 (MDC) # of Poles	
				4	5
2 + Ground	250V AC/DC (maximum)	None	Gray	VFN-029-3401	VFN-029-3501
			Black	VAN-029-3401	VAN-029-3501
2 + Ground	10-50V DC	LED w/ Flyback Diode	Clear	VAC-029-3401	VAC-029-3501
2 + Ground	24V AC/DC	LED w/ MOV	Clear	VAG-029-3401	VAG-029-3501
2 + Ground	120V AC/DC	LED w/ MOV	Clear	VAJ-029-3401	VAJ-029-3501
2 + Ground	120V AC/DC	Bridge Rectifier w/ LED & MOV	Clear	VAR-029-3401	VAR-029-3501

DIN Connector Specifications:

Body: Polyamide
 Contacts: Copper Alloy with Silver Plating
 Gasket: Thermoplastic
 Screw: Steel Zinc Plate
 Temperature: -40°C to 80°C (-40°F to +176°F)
 Protection: IP 65

MDC Connector Specifications:

Body: Nickel Plated Brass
 Insulator: Polyamide
 Contacts: Copper Alloy with Gold Plating
 O-Ring: BUNA-N
 Temperature: -40°C to 80°C (-40°F to +176°F)
 Protection: IP 65

DIN 43650 Form A	M12 (MDC) 4 Pole	M12 (MDC) 5 Pole
Pin #	Pin #	Pin #
1	4	4
2	3	3
Ground		5
3 Not Used	1, 2 & 5 Not Used	1 & 2 Not Used

The ground position is not connected on the 4 Pole Version.

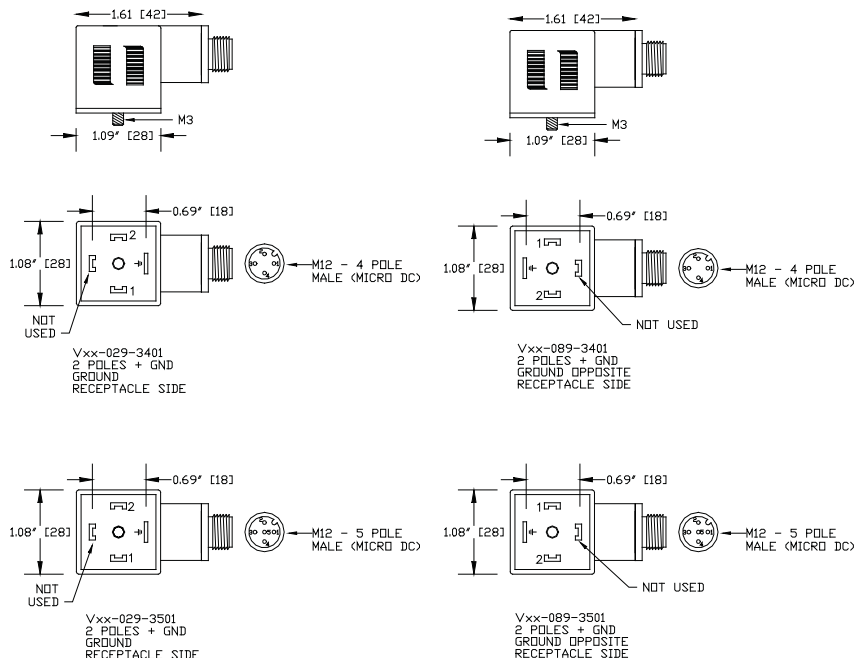

Solenoid Valve Connectors

DIN A to Micro-DC 4 Pole Male Plug ❖ DIN 43650 ❖ Form A to MDC (M12)

# of Poles	Voltage	Circuitry	M12 (MDC) 4 Pole Cable Straight Male			M12 (MDC) 4 Pole Cable Right Angle Male		
			2 M	5 M	10 M	2 M	5 M	10 M
2 + Ground	250V AC/DC (max.)	None	VAN-220-3401	VAN-520-3401	VAN-A20-3401	VAN-220-3402	VAN-520-3402	VAN-A20-3402
2 + Ground	24V AC/DC	LED w/ MOV	VAG-220-3401	VAG-520-3401	VAG-A20-3401	VAG-220-3402	VAG-520-3402	VAG-A20-3402
2 + Ground	120V AC/DC	LED w/ MOV	VAJ-220-3401	VAJ-520-3401	VAJ-A20-3401	VAJ-220-3402	VAJ-520-3402	VAJ-A20-3402

Other circuit options are available, please consult the factory.

Molded M12 Connectors are also available, please consult the factory for part number and minimum order quantities.

DIN Connector Specifications:

Body: Polyamide
 Contacts: Copper Alloy with Silver Plating
 Gasket: Thermoplastic
 Screw: Steel Zinc Plate
 Temperature: -40°C to 80°C (-40°F to +176°F)
 Protection: IP 65

DIN 43650 Form A	M12 (MDC) 4 Pole
Pin #	Pin #
1	4
2	3
Ground Not Used	1, 2 & 5 Not Used

MDC Connector Specifications:

Body: Nickel Plated Brass
 Insulator: Polyamide
 Contacts: Copper Alloy with Gold Plating
 O-Ring: BUNA-N
 Temperature: -40°C to 80°C (-40°F to +176°F)
 Protection: IP 65

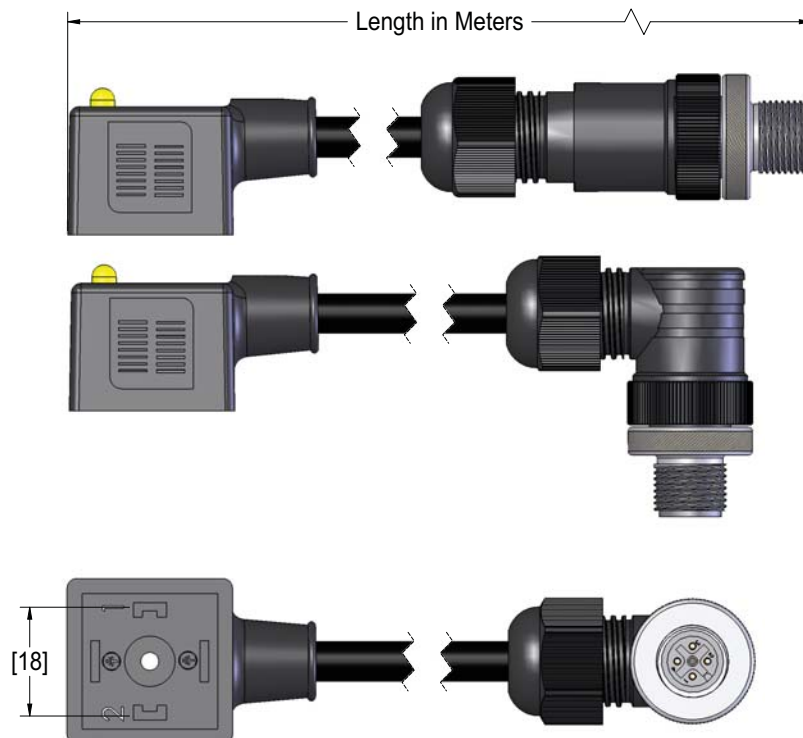

Valve Connectors

Solenoid Valve Connectors

DIN A to Micro-DC 5 Pole Male Plug ❖ DIN 43650 ❖ Form A to MDC (M12)

# of Poles	Voltage	Circuitry	M12 (MDC) 5 Pole Cable Straight Male			M12 (MDC) 5 Pole Cable Right Angle Male		
			2 M	5 M	10 M	2 M	5 M	10 M
2 + Ground	250V AC/DC (max.)	None	VAN-220-3501	VAN-520-3501	VAN-A20-3501	VAN-220-3502	VAN-520-3502	VAN-A20-3502
2 + Ground	24V AC/DC	LED w/ MOV	VAG-220-3501	VAG-520-3501	VAG-A20-3501	VAG-220-3502	VAG-520-3502	VAG-A20-3502
2 + Ground	120V AC/DC	LED w/ MOV	VAJ-220-3501	VAJ-520-3501	VAJ-A20-3501	VAJ-220-3502	VAJ-520-3502	VAJ-A20-3502

Other circuit options are available, please consult the factory.

Molded M12 Connectors are also available, please consult the factory for part number and minimum order quantities.

DIN Connector Specifications:

Body: Polyamide
 Contacts: Copper Alloy with Silver Plating
 Gasket: Thermoplastic
 Screw: Steel Zinc Plate
 Temperature: -40°C to 80°C (-40°F to +176°F)
 Protection: IP 65

DIN 43650 Form A	M12 (MDC) 5 Pole
Pin #	Pin #
1	4
2	3
Ground	5
	1 & 2 Not Used

MDC Connector Specifications:

Body: Nickel Plated Brass
 Insulator: Polyamide
 Contacts: Copper Alloy with Gold Plating
 O-Ring: BUNA-N
 Temperature: -40°C to 80°C (-40°F to +176°F)
 Protection: IP 65

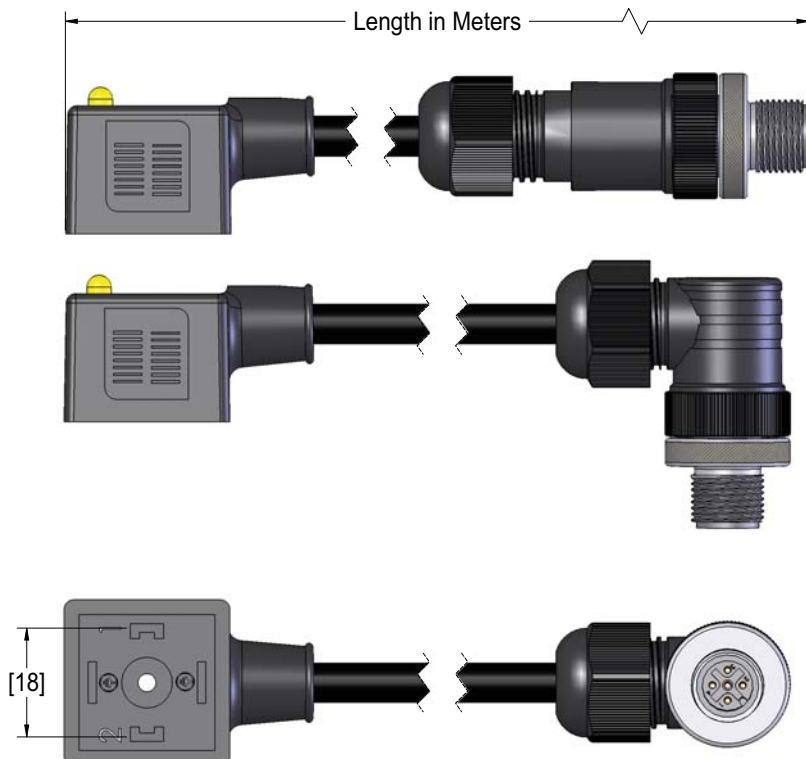

Solenoid Valve Connectors

Industry Standard Form B to Micro-DC Male Receptacle

# of Poles	Voltage	Circuitry	Housing Color	M12 (MDC) # of Poles	
				4	5
2 + Ground	250V AC/DC (maximum)	None	Gray	VJN-029-3401	VJN-029-3501
			Black	VDN-029-3401	VDN-029-3501
2 + Ground	10-50V DC	LED w/ Flyback Diode	Clear	VDC-029-3401	VDC-029-3501
2 + Ground	24V AC/DC	LED w/ MOV	Clear	VDG-029-3401	VDG-029-3501
2 + Ground	120V AC/DC	LED w/ MOV	Clear	VDJ-029-3401	VDJ-029-3501

DIN Connector Specifications:

Body: Polyamide
 Contacts: Copper Alloy with Silver Plating
 Gasket: Thermoplastic
 Screw: Steel Zinc Plate
 Temperature: -40°C to 80°C (-40°F to +176°F)
 Protection: IP 65

DIN 43650 I. S. B.	M12 (MDC) 4 Pole	M12 (MDC) 5 Pole
Pin #	Pin #	Pin #
1	4	4
2	3	3
Ground	Not Used	5
	1, 2 & 5 Not Used	1 & 2 Not Used

MDC Connector Specifications:

Body: Nickel Plated Brass
 Insulator: Polyamide
 Contacts: Copper Alloy with Gold Plating
 O-Ring: BUNA-N
 Temperature: -40°C to 80°C (-40°F to +176°F)
 Protection: IP 65

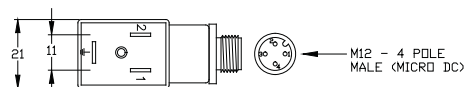
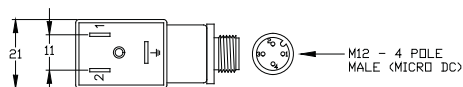
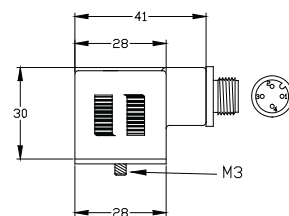
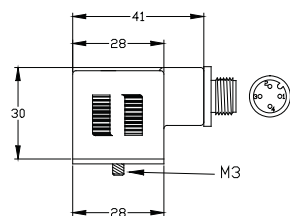

Vxx-029-3401
GROUND TOWARD RECEPTACLE SIDE

Vxx-089-3401
GROUND OPPOSITE RECEPTACLE SIDE

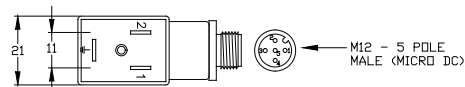
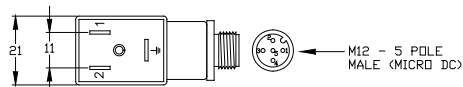

Vxx-029-3501
GROUND TOWARD RECEPTACLE SIDE

Vxx-089-3501
GROUND OPPOSITE RECEPTACLE SIDE

Valve Connectors

Solenoid Valve Connectors

Industry Standard Form B to Micro-DC Male Plug

# of Poles	Voltage	Circuitry	M12 (MDC) 4 Pole Cable Straight Male			M12 (MDC) 4 Pole Cable Right Angle Male		
			2 M	5 M	10 M	2 M	5 M	10 M
2 + Ground	250V AC/DC (max.)	None	VDN-220-3401	VDN-520-3401	VDN-A20-3401	VDN-220-3402	VDN-520-3402	VDN-A20-3402
2 + Ground	24V AC/DC	LED w/ MOV	VDG-220-3401	VDG-520-3401	VDG-A20-3401	VDG-220-3402	VDG-520-3402	VDG-A20-3402
2 + Ground	120V AC/DC	LED w/ MOV	VDJ-220-3401	VDJ-520-3401	VDJ-A20-3401	VDJ-220-3402	VDJ-520-3402	VDJ-A20-3402
# of Poles	Voltage	Circuitry	M12 (MDC) 5 Pole Cable Straight Male			M12 (MDC) 5 Pole Cable Right Angle Male		
			2 M	5 M	10 M	2 M	5 M	10 M
2 + Ground	250V AC/DC (max.)	None	VDN-220-3501	VDN-520-3501	VDN-A20-3501	VDN-220-3502	VDN-520-3502	VDN-A20-3502
2 + Ground	24V AC/DC	LED w/ MOV	VDG-220-3501	VDG-520-3501	VDG-A20-3501	VDG-220-3502	VDG-520-3502	VDG-A20-3502
2 + Ground	120V AC/DC	LED w/ MOV	VDJ-220-3501	VDJ-520-3501	VDJ-A20-3501	VDJ-220-3502	VDJ-520-3502	VDJ-A20-3502

Molded M12 Connectors are also available, please consult the factory for part number and minimum order quantities.

DIN Connector Specifications:

Body: Polyamide
 Contacts: Copper Alloy with Silver Plating
 Gasket: Thermoplastic
 Screw: Steel Zinc Plate
 Temperature: -40°C to 80°C (-40°F to +176°F)
 Protection: IP 65

DIN 43650 I. S. B.	M12 (MDC) 4 Pole	M12 (MDC) 5 Pole
Pin #	Pin #	Pin #
1	4	4
2	3	3
Ground	Not Used	5
	1, 2 & 5 Not Used	1 & 2 Not Used

MDC Connector Specifications:

Body: Nickel Plated Brass
 Insulator: Polyamide
 Contacts: Copper Alloy with Gold Plating
 O-Ring: BUNA-N
 Temperature: -40°C to 80°C (-40°F to +176°F)
 Protection: IP 65



Valve Connectors

Solenoid Valve Connectors

DIN 43650 Form C to Micro-DC Male Plug ❖ DIN 43650 ❖ Form C to MDC

# of Poles	Voltage	Circuitry	M12 (MDC) 4 Pole Cable Straight Male			M12 (MDC) 4 Pole Cable Right Angle Male		
			2 M	5 M	10 M	2 M	5 M	10 M
2 + Ground	250V AC/DC (max.)	None	VCN-220-3401	VCN-520-3401	VCN-A20-3401	VCN-220-3402	VCN-520-3402	VCN-A20-3402
2 + Ground	24V AC/DC	LED w/ MOV	VCG-220-3401	VCG-520-3401	VCG-A20-3401	VCG-220-3402	VCG-520-3402	VCG-A20-3402
2 + Ground	120V AC/DC	LED w/ MOV	VCJ-220-3401	VCJ-520-3401	VCJ-A20-3401	VCJ-220-3402	VCJ-520-3402	VCJ-A20-3402
# of Poles	Voltage	Circuitry	M12 (MDC) 5 Pole Cable Straight Male			M12 (MDC) 5 Pole Cable Right Angle Male		
			2 M	5 M	10 M	2 M	5 M	10 M
2 + Ground	250V AC/DC (max.)	None	VCN-220-3501	VCN-520-3501	VCN-A20-3501	VCN-220-3502	VCN-520-3502	VCN-A20-3502
2 + Ground	24V AC/DC	LED w/ MOV	VCG-220-3501	VCG-520-3501	VCG-A20-3501	VCG-220-3502	VCG-520-3502	VCG-A20-3502
2 + Ground	120V AC/DC	LED w/ MOV	VCJ-220-3501	VCJ-520-3501	VCJ-A20-3501	VCJ-220-3502	VCJ-520-3502	VCJ-A20-3502

Molded M12 Connectors are also available, please consult the factory for part number and minimum order quantities.

DIN Connector Specifications:

Body: Polyamide
 Contacts: Copper Alloy with Silver Plating
 Gasket: Thermoplastic
 Screw: Steel Zinc Plate
 Temperature: -40°C to 80°C (-40°F to +176°F)
 Protection: IP 65

MDC Connector Specifications:

Body: Nickel Plated Brass
 Insulator: Polyamide
 Contacts: Copper Alloy with Gold Plating

DIN 43650 Form C	M12 (MDC) 4 Pole	M12 (MDC) 5 Pole
Pin #	Pin #	Pin #
1	4	4
2	3	3
Ground	Not Used	5
	1,2 & 5 Not Used	1 & 2 Not Used

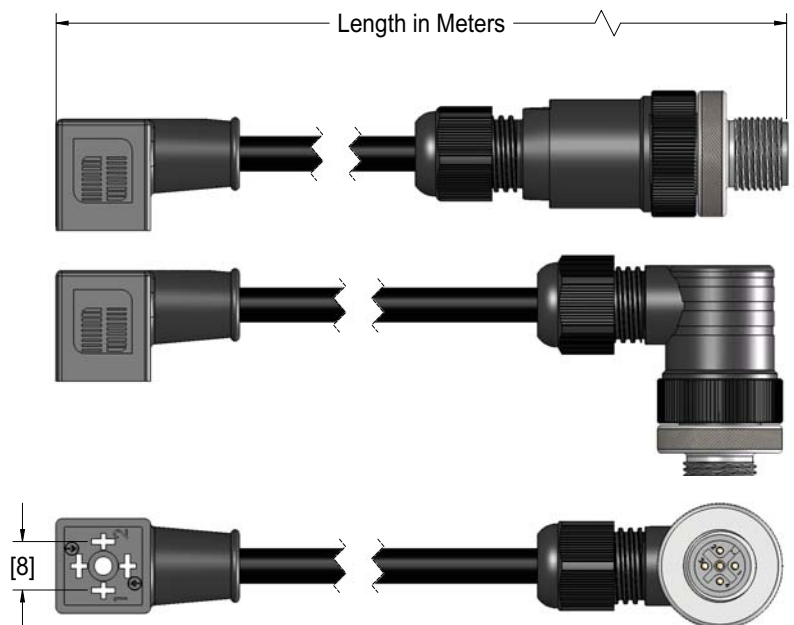

Solenoid Valve Connectors

Industry Standard Form C to Micro-DC Male Plug

# of Poles	Voltage	Circuitry	M12 (MDC) 4 Pole Cable Straight Male			M12 (MDC) 4 Pole Cable Right Angle Male		
			2 M	5 M	10 M	2 M	5 M	10 M
2 + Ground	250V AC/DC (max.)	None	VEN-220-3401	VEN-520-3401	VEN-A20-3401	VEN-220-3402	VEN-520-3402	VEN-A20-3402
2 + Ground	24V AC/DC	LED w/ MOV	VEG-220-3401	VEG-520-3401	VEG-A20-3401	VEG-220-3402	VEG-520-3402	VEG-A20-3402
2 + Ground	120V AC/DC	LED w/ MOV	VEJ-220-3401	VEJ-520-3401	VEJ-A20-3401	VEJ-220-3402	VEJ-520-3402	VEJ-A20-3402
# of Poles	Voltage	Circuitry	M12 (MDC) 5 Pole Cable Straight Male			M12 (MDC) 5 Pole Cable Right Angle Male		
			2 M	5 M	10 M	2 M	5 M	10 M
2 + Ground	250V AC/DC (max.)	None	VEN-220-3501	VEN-520-3501	VEN-A20-3501	VEN-220-3502	VEN-520-3502	VEN-A20-3502
2 + Ground	24V AC/DC	LED w/ MOV	VEG-220-3501	VEG-520-3501	VEG-A20-3501	VEG-220-3502	VEG-520-3502	VEG-A20-3502
2 + Ground	120V AC/DC	LED w/ MOV	VEJ-220-3501	VEJ-520-3501	VEJ-A20-3501	VEJ-220-3502	VEJ-520-3502	VEJ-A20-3502

Molded M12 Connectors are also available, please consult the factory for part number and minimum order quantities.

DIN Connector Specifications:

Body: Polyamide
 Contacts: Copper Alloy with Silver Plating
 Gasket: Thermoplastic
 Screw: Steel Zinc Plate
 Temperature: -40°C to 80°C (-40°F to +176°F)
 Protection: IP 65

I.S.C	M12 (MDC) 4 Pole	M12 (MDC) 5 Pole
Pin #	Pin #	Pin #
1	4	4
2	3	3
Ground	Not Used	5
	1,2 & 5 Not Used	1 & 2 Not Used

MDC Connector Specifications:

Body: Oil Resistant Yellow PVC
 Insulator: Polyamide
 Contacts: Copper Alloy with Gold Plating



