



JAN Junction Blocks NAN Series

4 Port 2-3

6 Port 4-5

8 Port 6-7

JAN Junction Blocks 4 Port ❖ 3 Pin

Field Wireable ❖ Cable ❖ MIN Receptacle ❖ MDC Receptacle

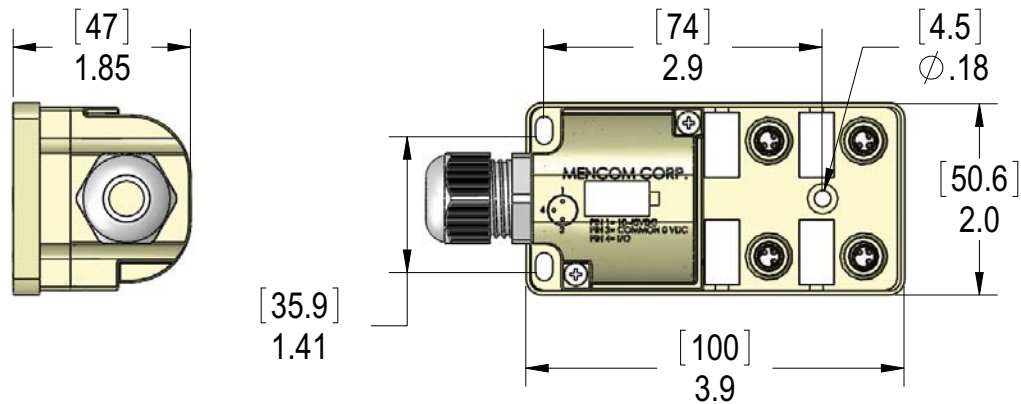

Field Wireable

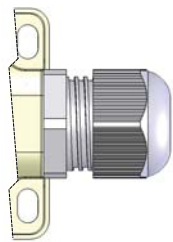

Cable

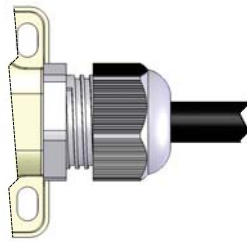

MIN Receptacle

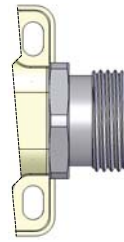

MDC Receptacle



Trunk Connection	Length	Part Number		
		No LED	PNP	NPN
Field Wireable	N/A	JAN-430-006-F000	JAN-43P-206-F000	JAN-43N-206-F000
Cable	2 M	JAN-430-006-C020	JAN-43P-206-C020	JAN-43N-206-C020
	5 M	JAN-430-006-C050	JAN-43P-206-C050	JAN-43N-206-C050
	10 M	JAN-430-006-C100	JAN-43P-206-C100	JAN-43N-206-C100
MIN-6MR Receptacle	N/A	JAN-430-006-M000	JAN-43P-206-M000	JAN-43N-206-M000
MDC-8MR Receptacle	N/A	JAN-430-008-E000	JAN-43P-208-E000	JAN-43N-208-E000

JAN Junction Blocks 4 Port ❖ 3 Pin

Field Wireable ❖ Cable ❖ MIN Receptacle ❖ MDC Receptacle

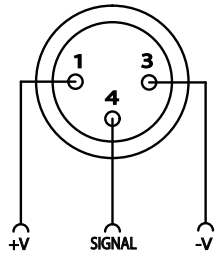

No LED Version

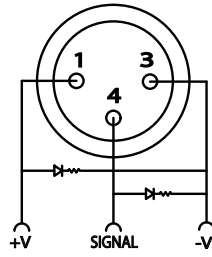

PNP Version

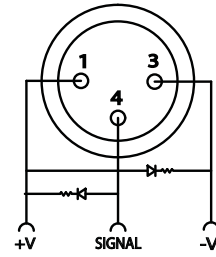

NPN Version

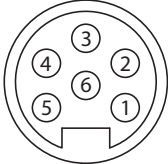
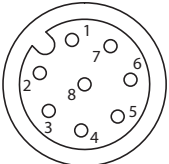
Function	MIN-6MR Receptacle Version	MDC-8MR Receptacle Version	Cable
			Cable O.D. 8.9 mm
+ V	PIN #6	PIN #5	Brown
- V	PIN #3	PIN #1	Blue
PORT 1 PIN 4 (L4)	PIN #2	PIN #2	White
PORT 2 PIN 4 (L4)	PIN #1	PIN #3	Green
PORT 3 PIN 4 (L4)	PIN #5	PIN #4	Yellow
PORT 4 PIN 4 (L4)	PIN #4	PIN #2	Gray
Mating Plug	MIN-6FP-ZZ	MDCP-8FP-ZZ	

JAN Junction Blocks 6 Port ❖ 3 Pin

Field Wireable ❖ Cable ❖ MIN Receptacle ❖ MDC Receptacle

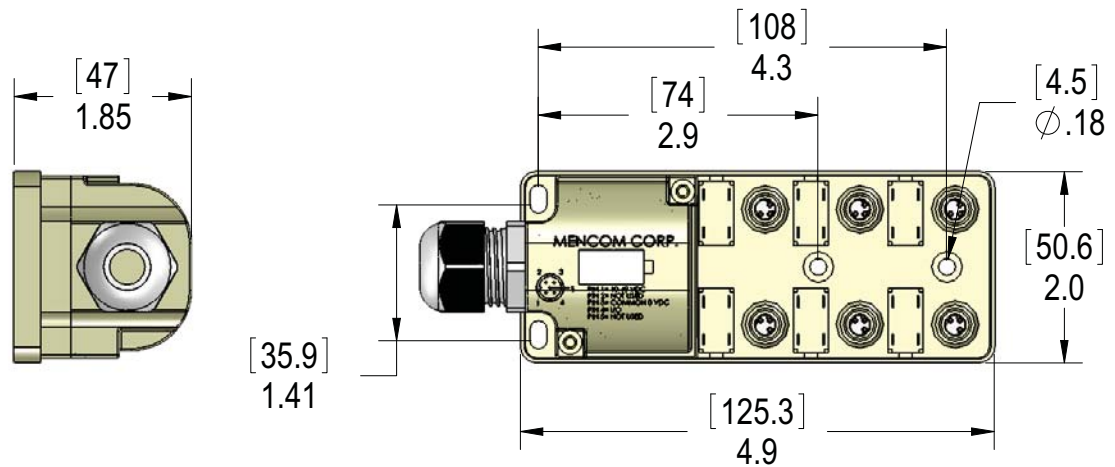

Field Wireable

Cable

MIN Receptacle

MDC Receptacle

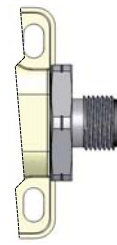
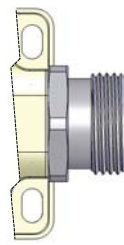
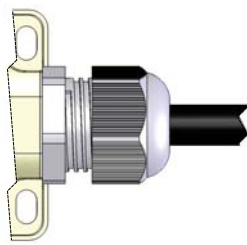
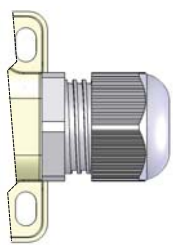

Trunk Connection	Length	Part Number		
		No LED	PNP	NPN
Field Wireable	N/A	JAN-630-008-F000	JAN-63P-208-F000	JAN-63N-208-F000
Cable	2M	JAN-630-008-C020	JAN-63P-208-C020	JAN-63N-208-C020
	5 M	JAN-630-008-C050	JAN-63P-208-C050	JAN-63N-208-C050
	10 M	JAN-630-008-C100	JAN-63P-208-C100	JAN-63N-208-C100
MIN-8MR Receptacle	N/A	JAN-630-008-M000	JAN-63P-208-M000	JAN-63N-208-M000
MDC-8MR Receptacle	N/A	JAN-630-008-E000	JAN-63P-208-E000	JAN-63N-208-E000

JAN Junction Blocks 6 Port ❖ 3 Pin

Field Wireable ❖ Cable ❖ MIN Receptacle ❖ MDC Receptacle

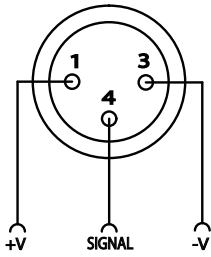

No LED Version

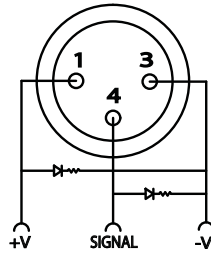

PNP Version

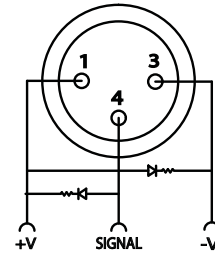

NPN Version

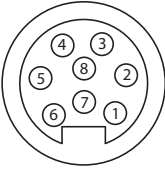
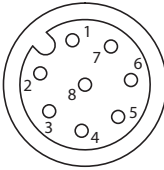
Function	MIN-8MR Receptacle Version	MDC-8MR Receptacle Version	Cable
			Cable O.D. 9.5 mm
+ V	PIN #8	PIN #5	Brown
- V	PIN #7	PIN #7	Blue
PORT 1 PIN 4	PIN #6	PIN #1	White
PORT 2 PIN 4	PIN #5	PIN #2	Green
PORT 3 PIN 4	PIN #4	PIN #3	Yellow
PORT 4 PIN 4	PIN #3	PIN #4	Gray
PORT 5 PIN 4	PIN #2	PIN #6	Pink
PORT 6 PIN 4	PIN #1	PIN #8	Red
Mating Plug	MIN-8FPX-ZZ	MDCP-8FP-ZZ	

JAN Junction Blocks 8 Port ❖ 3 Pin

Field Wireable ❖ Cable ❖ MIN Receptacle ❖ MDC Receptacle

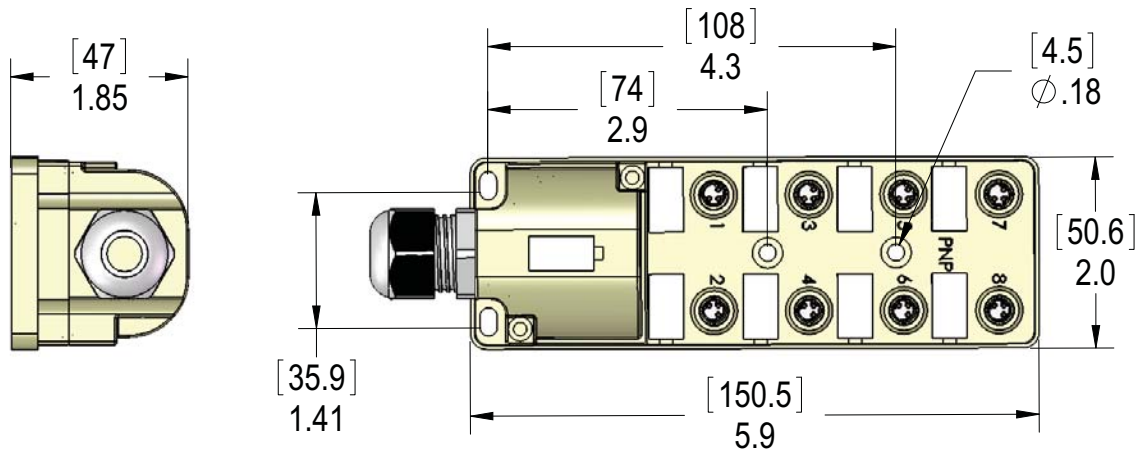

Field Wireable

Cable

MIN Receptacle

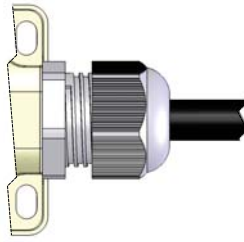
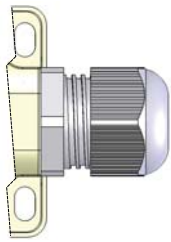

Trunk Connection	Length	Part Number		
		No LED	PNP	NPN
Field Wireable	N/A	JAN-830-010-F000	JAN-83P-210-F000	JAN-83N-210-F000
Cable	2M	JAN-830-010-C020	JAN-83P-210-C020	JAN-83N-210-C020
	5 M	JAN-830-010-C050	JAN-83P-210-C050	JAN-83N-210-C050
	10 M	JAN-830-010-C100	JAN-83P-210-C100	JAN-83N-210-C100
MIN-10MR Receptacle	N/A	JAN-830-010-M000	JAN-83P-210-M000	JAN-83N-210-M000

JAN Junction Blocks 8 Port ❖ 3 Pin

Field Wireable ❖ Cable ❖ MIN Receptacle ❖ MDC Receptacle

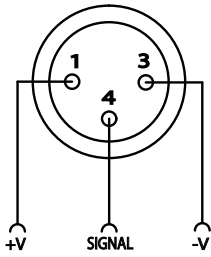

No LED Version

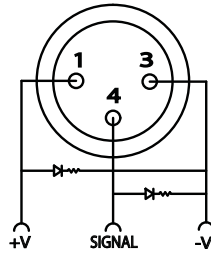

PNP Version

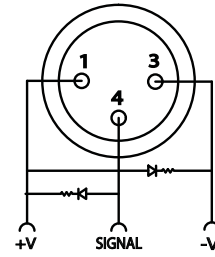

NPN Version

Function	MIN-10MR Receptacle Version	Cable
		Cable O.D. 9.5 mm
+ V	PIN #10	Brown
- V	PIN #8	Blue
PORT 1 PIN 4	PIN #7	White
PORT 2 PIN 4	PIN #6	Green
PORT 3 PIN 4	PIN #5	Yellow
PORT 4 PIN 4	PIN #4	Gray
PORT 5 PIN 4	PIN #3	Pink
PORT 6 PIN 4	PIN #2	Red
PORT 7 PIN 4	PIN #1	Black
PORT 8 PIN 4	PIN #9	Violet
Mating Plug	MIN-10FPX-ZZ	

